

HZ-3521A
Three-phase Electric Energy
Meter Field Calibrator

User Manual

Contents

I.Overview.....	1
II.Functions and Features.....	1
III.Input Characteristics.....	2
IV.Panel Description.....	2
V.Wiring Method.....	5
VI.Method of Use.....	8
VII.After-sales Service.....	12

I. Overview

HZ-3521A three-phase watt-hour meter field calibrator is specially designed for on-site inspection of high-voltage power grid metering devices and fault detection. The instrument USES high-precision internal transformer and clamp type transformer for sampling, so that operators can quickly, safely and reliably measure meter recording errors and wiring errors. It provides an effective basis for electric power system inspectors to check electric theft and leakage, find out the failure of metering device, measure correctly and recover electric quantity.

HZ-3521A three-phase watt-hour meter field calibrator adopts the current popular ARM processor, 168M main frequency 128M memory expend 4G memory card. LCD adopts 7-inch hd color touch screen, combined with emwin display interface, which makes the instrument interface friendly and simple to operate, and can operate with full touch screen without keyboard. The instrument supports a file system that seamlessly connects to the computer.

II. Functions and Features

2.1 In the case of no power failure, without changing the wiring of the metering circuit, the error of the metering device is detected to determine whether the metering device is faulty.

2.2 It can measure a variety of electrical parameters such as voltage, current, power, phase angle, power factor, frequency, etc., so as to accurately determine the fault of the measuring device circuit.

2.3 can measure CT ratio error and phase angle (optional function).

2.4 Display vector diagram of three-phase voltage and current, which can visually check the wiring error of the metering device.

2.5 Current loops are measured using clamp-type transformers, allowing operators to make measurements quickly, easily, safely and reliably without opening the current loop.

2.6 Can not change the wiring to detect the integrated error of the reactive energy meter.

2.7 The instrument has waveform display and harmonic analysis function. The instrument can display the voltage and current waveforms of each channel at the same time or separately. The instrument can analyze the 1-32 harmonic content and harmonic values and draw a column chart.

2.8 Built-in emwin operating system, 7-inch true color LCD display, no keyboard full touch operation, one screen can display a variety of electrical parameters.

III.Input Characteristics

3.1 Input characteristics

Voltage 2~450V automatic conversion limit

Clamp type current transformer measurement range: 0.1~5A (20A, 100A, 500A optional)

Phase angle: 0~359.9°

Frequency: 45 ~ 55Hz

3.2 Accuracy: 0.05

3.3 Working temperature: -20°C ~ +50°C

3.4 working power: 80V~265VAC

Machine power consumption: ≤3VA

3.5 volume: length: 280mm, width: 200mm, height: 75mm

3.6 weight: 2.5kg

3.7 insulation

a. The insulation resistance of the voltage and current input terminals to the casing is

≥100MΩ

b. The working power input end is subjected to a power frequency of 2kV (effective value)

between the outer casings for 1 minute.

IV.Panel Description

4.1 Panel layout



Ua (yellow), Ub (green), Uc (red) : are terminal buttons of the voltage input loop, and Un (black) is the ground wire.

A, B and C - are three phase input jacks for clamp table A, B and C. Pulse - for calibration pulse input jack, and low frequency pulse output jack. The specific wiring diagram is as follows: +5V -- working power supply of photoelectric head, signal input terminal -- pulse input port of photoelectric head (pulse meter), ground -- working power supply and the same name end of signal input.

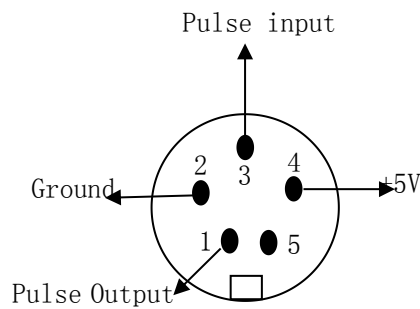

Pulse output constant:

(220V)5A:FL=6000 (380V)5A:FL=3000

50A:FL=600 (380V)50A:FL=300

500A:FL=60 (380V)500A:FL=30

(100V/60V)5A:FL=12000

50A:FL=1200

500A:FL=120

4.2 Keyboard instructions

Touch screen operation, with 16 keys numeric keyboard and numeric pinyin full keyboard (similar to computer keyboard). Numeric key "0-9" : used for data input in the parameter input state. "Q-m" is used to input user name or transformer model in letter or full spelling Chinese character input method, "ABC" is used to switch from numeric keyboard to alphabetic keyboard, "123" is used to switch from alphabetic keyboard to numeric keyboard, and "X" is used to close soft keyboard. "Keybod" is used to move the keyboard around freely on the screen. Click the key to drag the keyboard to any position on the screen. "Back" is the backspace key to clear the previous character of the cursor, "CE" is used to clear all characters of the current input item, and "Ent" is the enter confirmation key.

As shown in figure:



V.Wiring Method

5.1 Correct wiring and use

a. Connect the power plug of the instrument to the power supply (220V) and turn on the power switch. For field use, use a short power cord, one end connected to the black terminal Un, and the other end connected to any one (220V).

b. The polarity marked on the panel by the voltage terminal button corresponds to the wiring.

Three-phase four-wire clamp meter wiring: A, B, C phase voltage is connected to yellow (Ua), green (Ub), red (Uc) terminal, three-phase neutral point (zero line) to black button (Un) .

Insert the A, B, C clamp meter according to the panel label

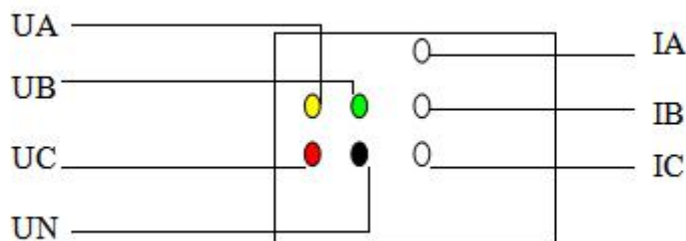

Three-phase three-wire clamp meter wiring: A phase voltage is connected to the yellow end button (Ua), phase C voltage is connected to the red end button (Uc), and phase B voltage is connected to the black end button (Un).

Insert the A and C clamp meters according to the panel label

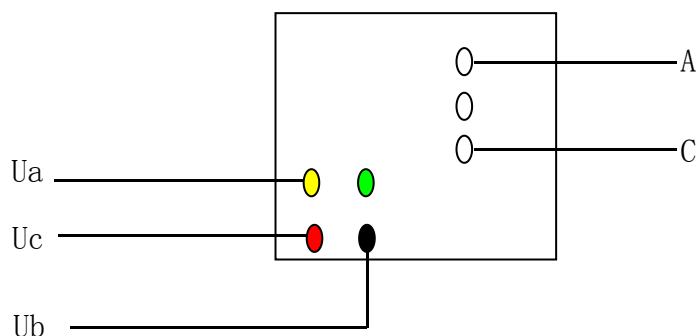

Single-phase clamp meter wiring: Select the detector A phase input (note the polarity end). The voltage is connected to the yellow button (Ua) and the neutral button is connected to the black button (Un).

Insert the A clamp meter according to the panel label

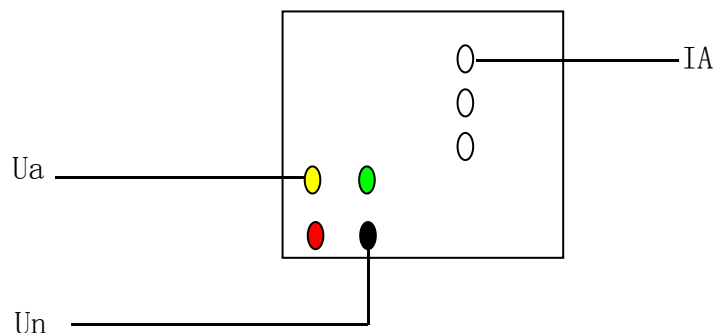

Single-phase wiring: Insert a clamp meter according to the panel label

It should be noted that the clamp-type table incision should be kept clean and clean, and it is not necessary to contaminate other sundries to ensure that the clamp-type watch is closed well when used.

c. Current loop wiring:

Three-phase four-wire wiring: A, B and C phase voltages are respectively connected with yellow (U_a), green (U_b) and red (U_c) terminals, and the three-phase neutral point (zero) is connected with black terminal knob (U_n).

Insert A, B, C phase current lines as indicated on the panel

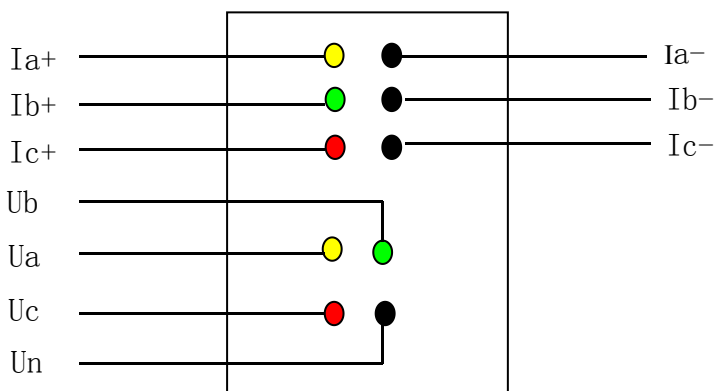

Three-phase three-wire connection: A phase voltage is connected to the yellow end button (U_a), phase C voltage is connected to the red end button (U_c), and phase B voltage is connected to the black end button (U_n)

Insert A and C phase current lines as indicated on the panel

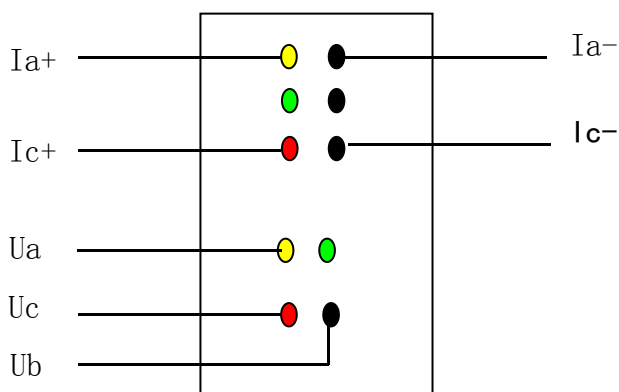

Single-phase wiring: Select the detector A phase input (note the polarity end). The voltage is connected to the yellow button (Ua) and the neutral button is connected to the black button (Un).

Insert A phase current line as indicated on the panel

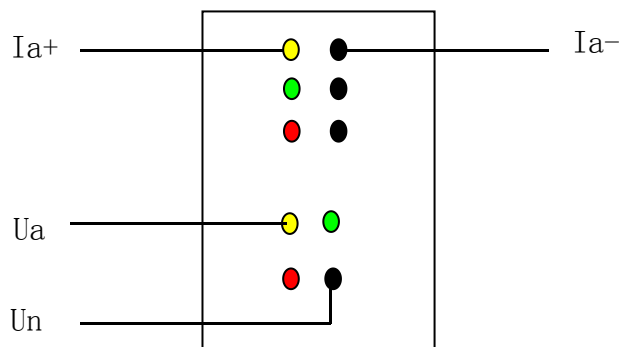

5.2 Manual calibration

First enter the parameter setting menu, input the calibration constant, the number of calibration turns, CT ratio (such as 200/5). Select the active meter (or reactive meter), select the manual input mode, connect the manual switch plug to the measured input of the detector, and the black mark with the meter turntable is out of date, press the manual switch, and the timing starts. When the black mark is rotated by the corresponding number of turns for the corresponding number of times, press the manual switch to complete the timing and automatically display the error of the device under test.

When using the photo head or the check pulse meter, the input mode can select the pulse, and the other settings are the same as the manual calibration.

VI.Method of Use

6.1 Boot interface is shown in the figure below:



Click the [Next] menu under the main interface to enter the instrument test interface, as shown below:

6.2 Parameter measurement

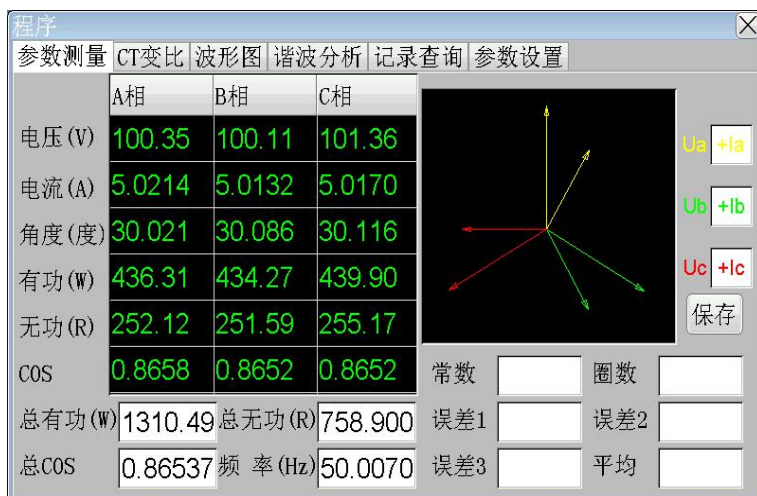

6.3 Meter calibration

Error of watt-hour meter can be measured under parameter measurement interface. (parameter setting should be carried out before measuring the error of the watt-hour meter. See parameter setting.)

Interface display:



After the verification, press the "Save" button to store the calibration error and electrical parameters. The stored results can be searched in the record query or uploaded to the computer.

6.4 CT measurement variable ratio

After entering this phase, it is possible to measure whether the CT ratio is correct.

Interface display:

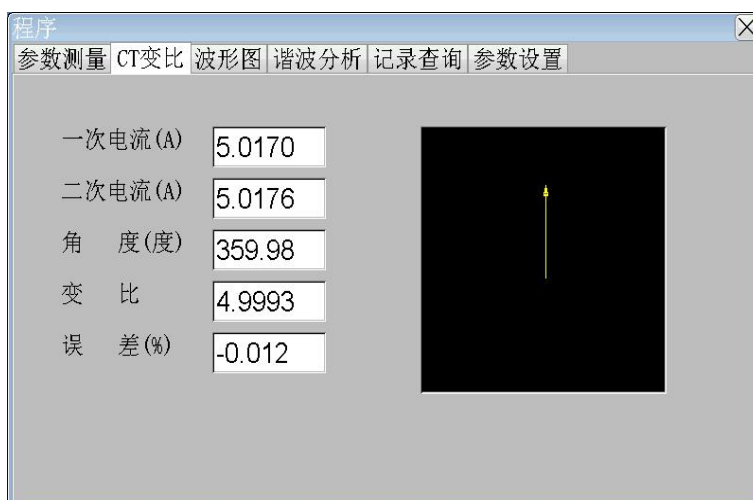

Select and enter the menu of measuring CT variable ratio. A phase clamp table is clamped on the primary side of CT, and C phase clamp table is clamped on the secondary side of CT. At this time, the interface displays primary current value, secondary current value, CT primary and secondary current phase Angle and CT variable ratio.

6.5 Waveform figure

Enter the waveform interface to display the waveform of voltage and current of each phase.

As shown below:

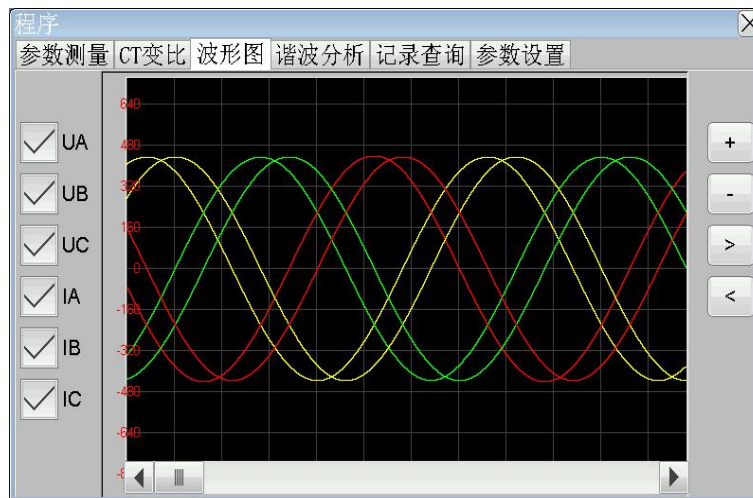

Press the corresponding buttons of UA, UB, UC, IA, IB and IC to display or close the waveform. Click the buttons of [+] and [-] to enlarge or reduce the waveform, [<] and [>] to stretch the waveform, and move the slider below to move the waveform.

6.6 Harmonic analysis

Enter the harmonic analysis option to select which phase of the harmonic to display, set as shown below:

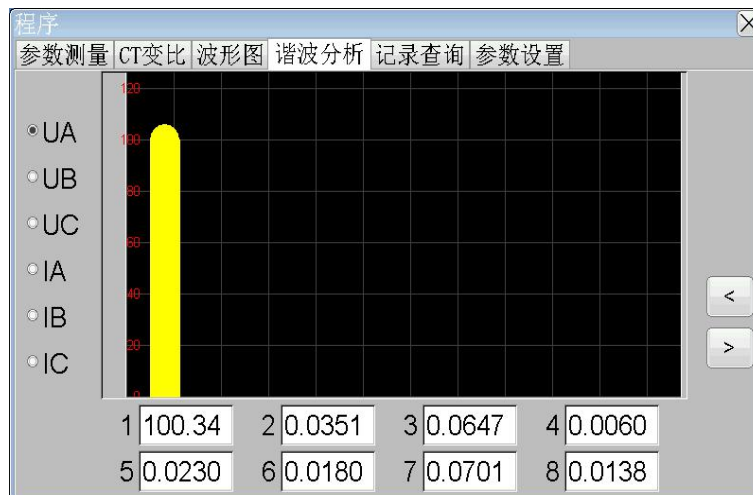

As shown in the figure, the harmonics of UA are displayed. After setting, press [confirm] to display the content and percentage of 1-32 harmonics of UA. Press [<] and [>] to display the content and percentage of 1-32 harmonics cyclically.

6.7 Record query

After entering the record query, select the calibration record, you can query the energy

meter verification record.:



(this machine can support serial printer to print record on site, and [export] function is reserved for the upgrade of this product)

This machine standard configuration does not have a printer.

Record can be selected from the record box on the left side, and detailed records can be viewed by clicking the record box on the right side.

6.8 Parameter Settings

Select the meter parameters to verify the meter Settings as follows



Set parameters such as the constant of the meter under test, the number of cycles of the meter, and the CT variable ratio, and select manual and pulse calibration methods (manual means manual switch manual calibration, and pulse means photoelectric probe or pulse input verification). After the setup is completed, click the save and modify button, and the system prompts save successfully, which can be included into the interface of the

calibration.

The debugging mode is the function used in the factory inspection. Users should not enter this function to avoid affecting the accuracy of the instrument.

Reactive meter test:

When the instrument measures and inspects the three-phase four-wire cross-phase 90° dynamometer metering device, the wiring method is the same as that of the active meter, and only when the “active power meter” or “reactive power” mode is selected when the “check power meter error” function interface is selected. By selecting the "reactive power" check, the comprehensive error of the low-voltage metering device (with built-in reactive power meter) and the basic error of the electric energy meter can be checked. The other detection methods are the same as the active meter.

A voltage metering device consisting of three single-phase electric energy meters is detected. According to the single-phase wiring, the three-phase can be detected separately, and the method of use is the same as the three-phase four-wire metering device.

VII.After-sales Service

Within one year from the date of purchase, the instrument belongs to the company's product quality problems for free maintenance, providing maintenance and technical services for life. If the instrument is found to be abnormal or malfunctioning, please contact the company in time to arrange the most convenient treatment plan and provide you with the fastest on-site service.